



### Connect the cables and set the DIP Switch

1. Connect the power cables between inverter and battery or the Busbars .  
See the Figure 2.1.7.1 to check the position of Luxpower Battery Connectors.

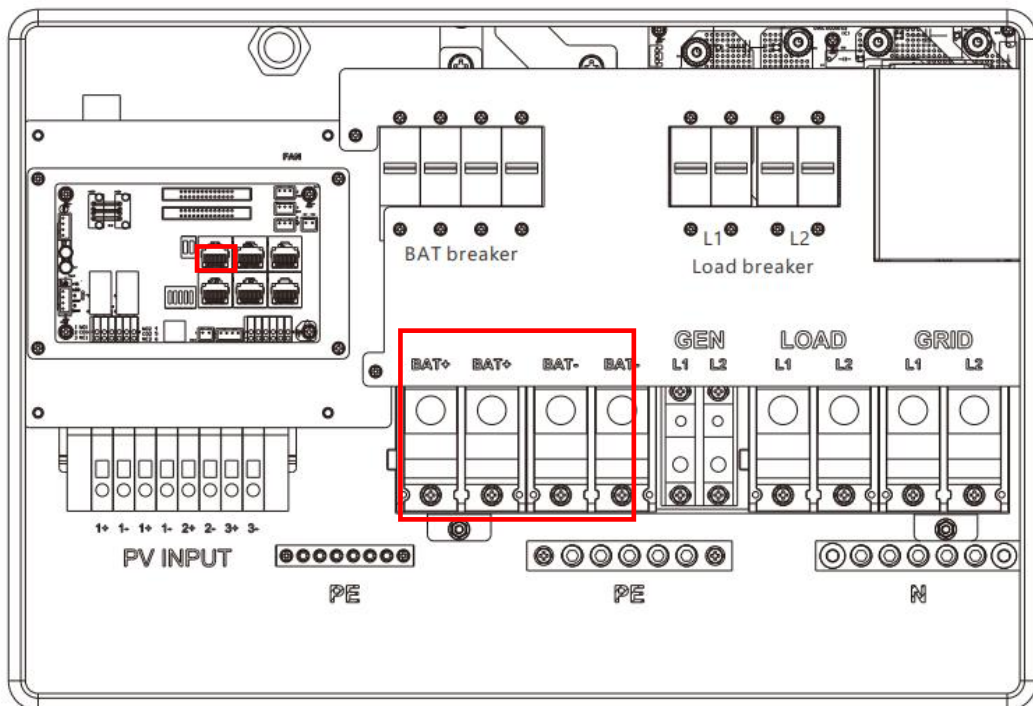

Figure 2.1.7.1 Luxpower Battery Connectors

2.A standard ethernet cable can be used for the communication since Luxpower inverter pin assignment is the same as Pytes E-BOX battery.

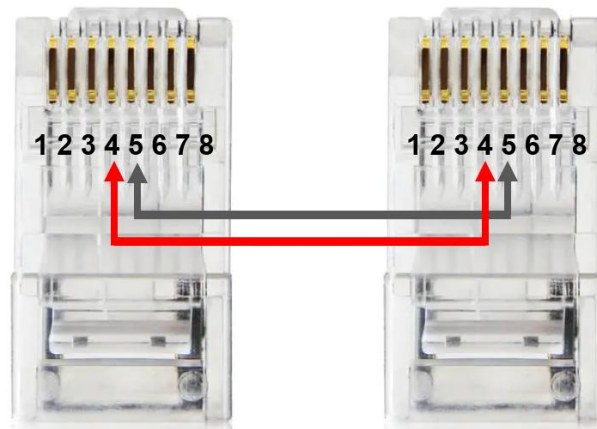

Figure 2.1.7.2 Luxpower ethernet cable

Plug in the battery end into the **CAN Port** of the Pytes E-BOX battery and plug in the inverter end into Luxpower **BAT COM Port** as shown in the Figure 2.1.7.3.

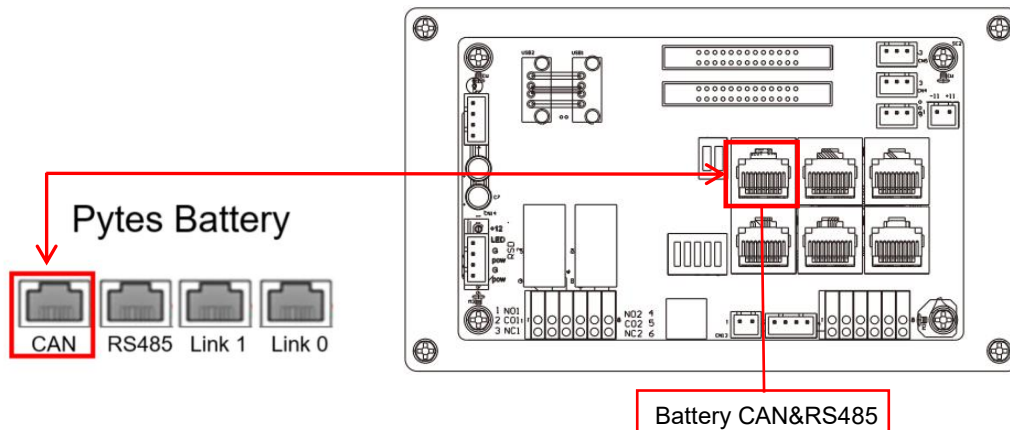

Figure 2.1.7.3 Luxpower inverter comm cable connection

3.Set the battery DIP switch as shown in the Figure 2.1.7.4

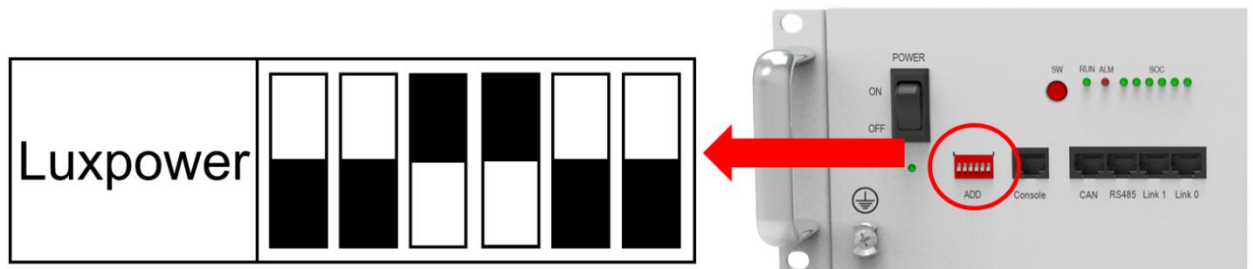

Figure 2.1.7.4 Luxpower DIP switch setting

## Set the inverter

After battery power cable and communication cable connection, users need to enter Advanced settings and choose Battery type and brand on the inverter LCD. After you choose the right battery protocol, the communication will be build in 1-2 minutes.

STEP 1 Touch the **Setting icon** of screen.

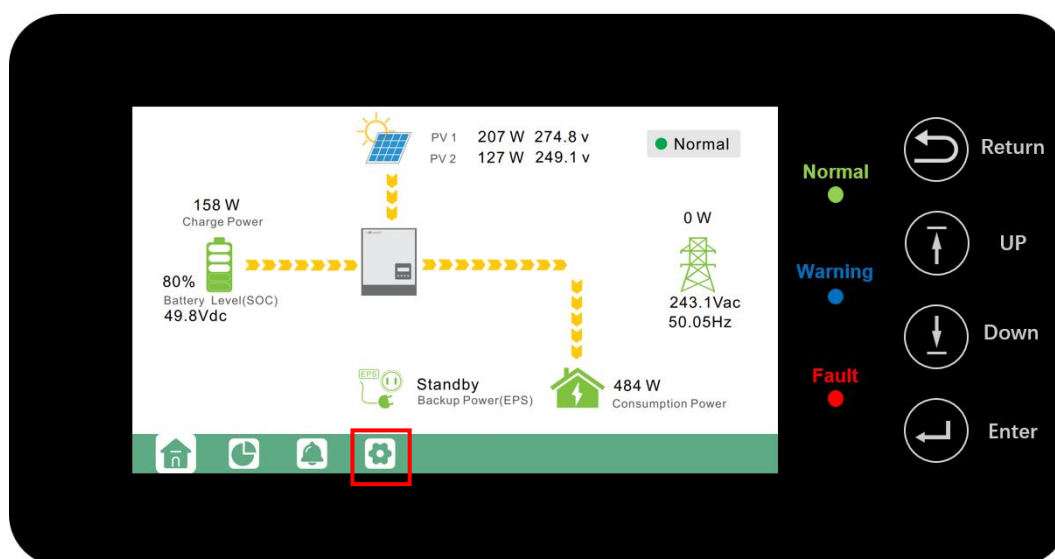

Figure 2.1.7.5 Home page

STEP 2 Touch **Advanced** and turn down a page ,then choose **2:Lithium** in Battery type.

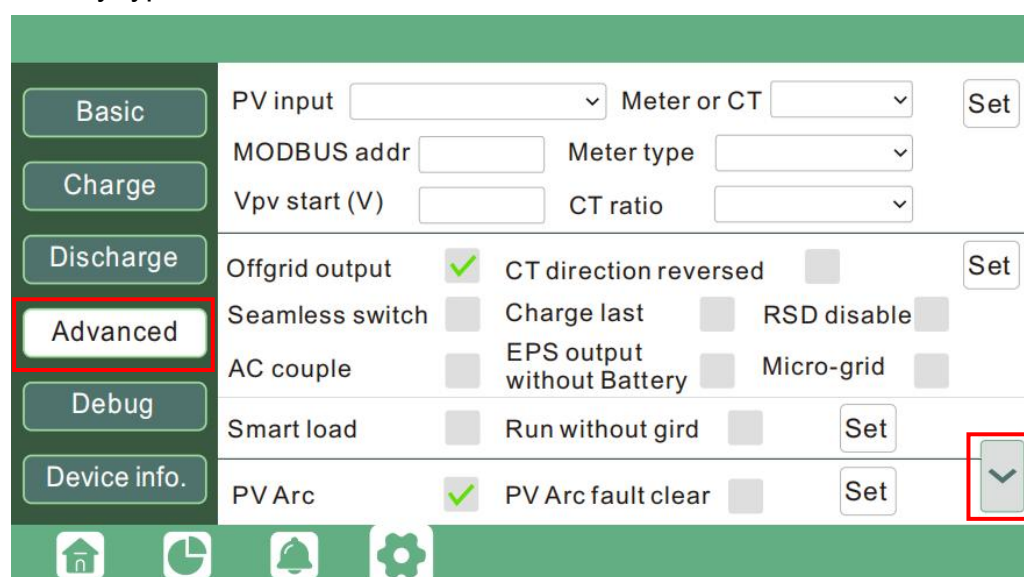

Figure 2.1.7.6 Advanced setting page

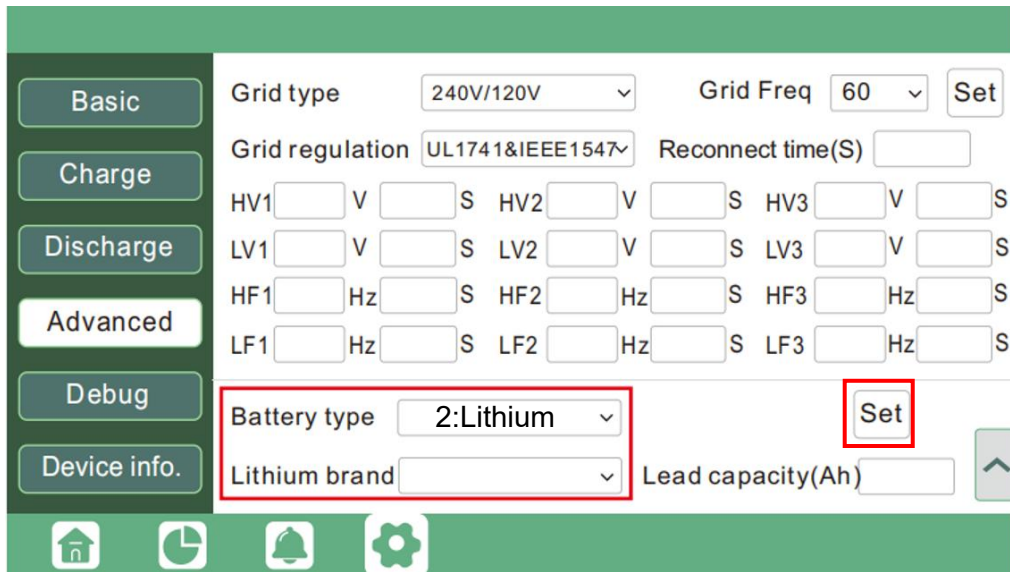

Figure 2.1.7.7 Advanced setting page

STEP 3 Choose Lithium brand. The password is required to select the battery brand. Password is **00000**. Pytes battery should choose **Lithium\_6**.

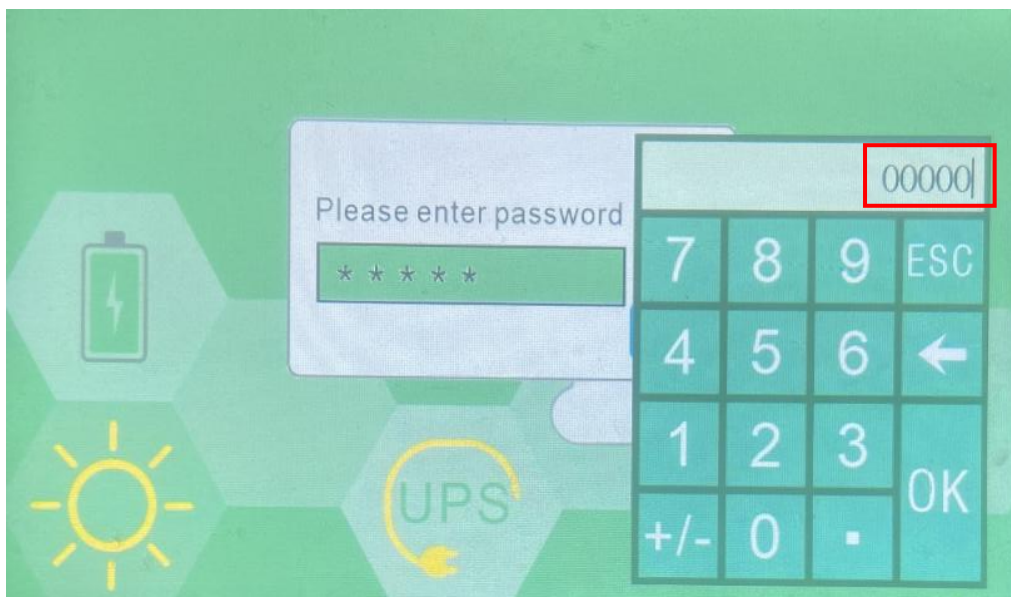

Figure 2.1.7.8 password input page

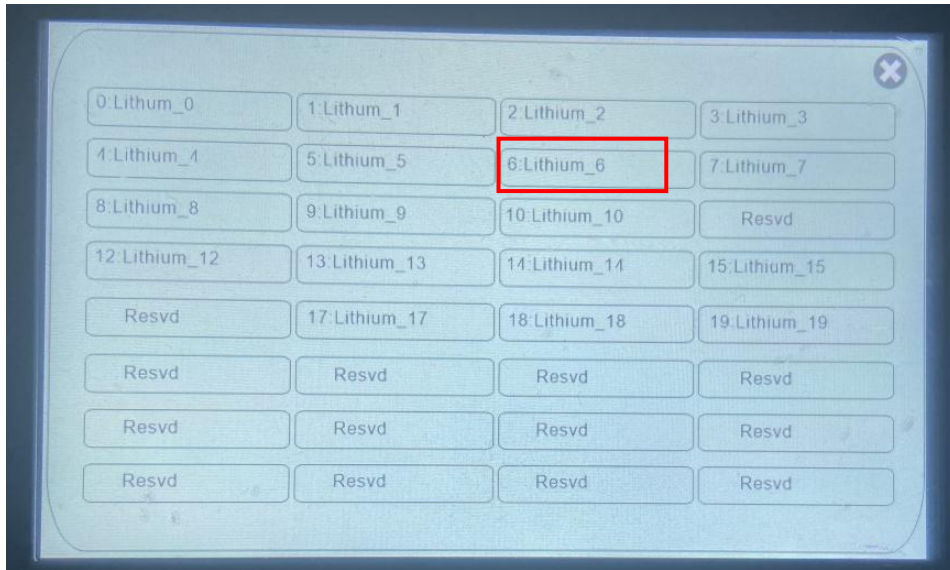

Figure 2.1.7.9 Choose battery brand page(choose **Lithium\_6**).

STEP 4 If battery communicate with inverter successful,battery page will show the specific SOC of battery.Home page battery icon will turn to green(if communication fail ,battery icon will turn to red).

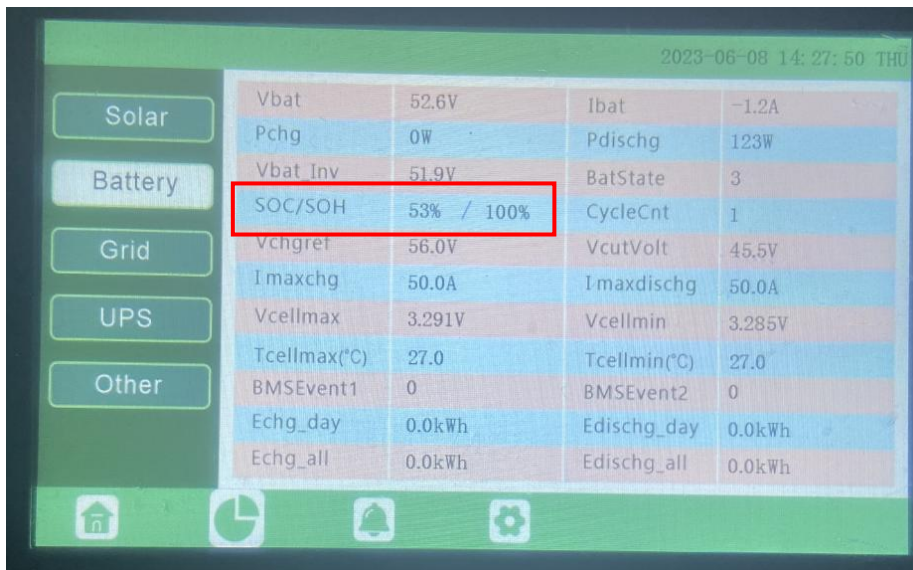

Figure 2.1.7.10 battery information page

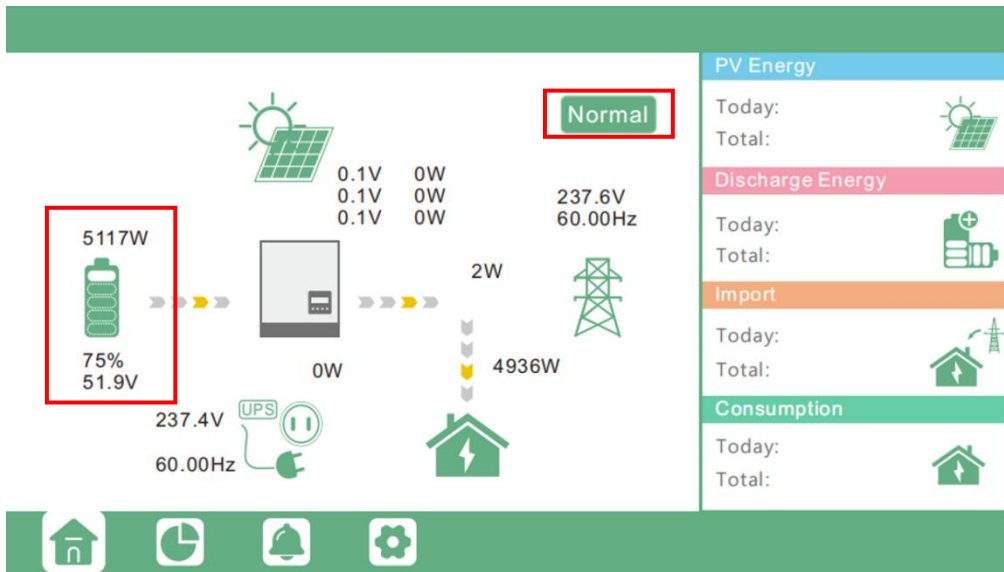
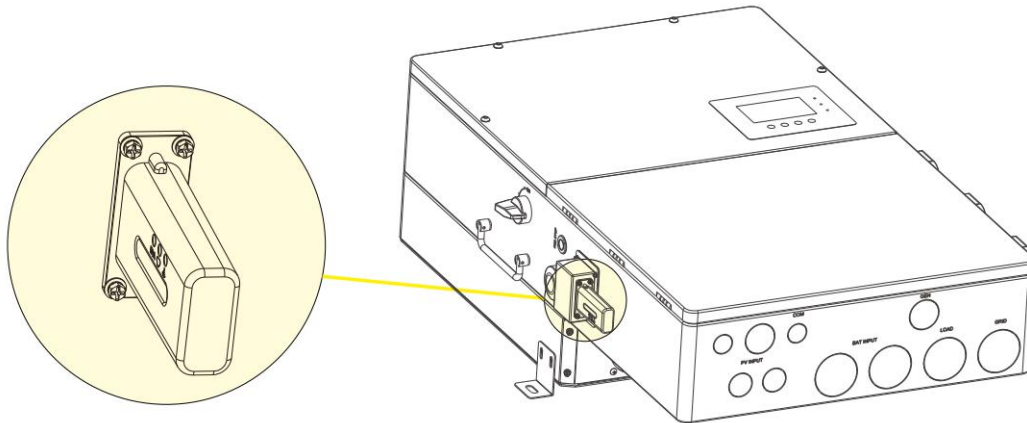

Figure 2.1.7.11 Home page

### Monitor System Setup

Users can use a WiFi/ WLAN /4G /2G dongle to monitor their inverter, and view the monitoring data on a computer or smart phone remotely.



To view data on smart phone, please download APP from the Google Play or Apple APP store, then login with their user account. Please refer to [Luxpower inverter manual](#) for more settings.



For Android



For IOS