

V5 BK1 Installation Guide

1. Install the brackets to battery

Battery top cover where the labels are pasted should go to wall, and battery bottom faces outside.

Refer to the multi-angled pictures to determine and align the 4 brackets to right positions.

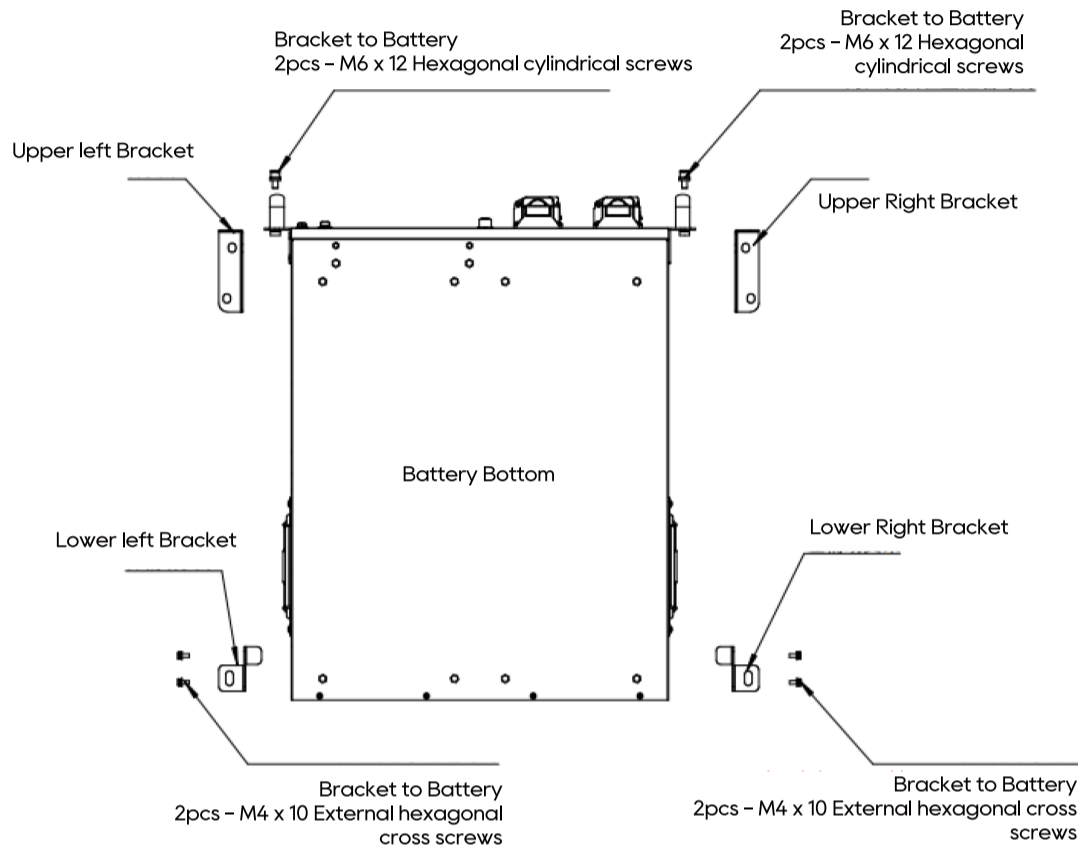

Battery Bottom View

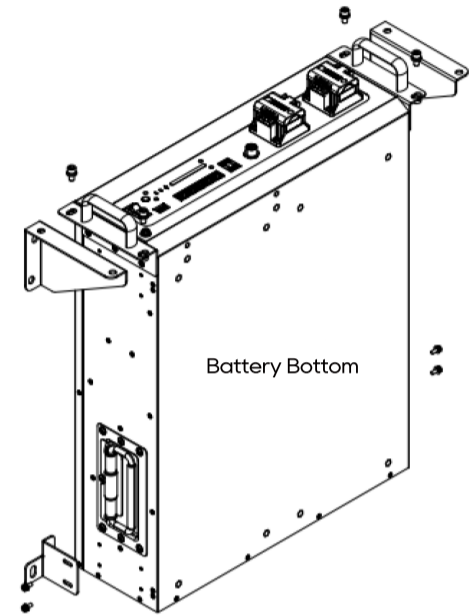

Left Oblique View



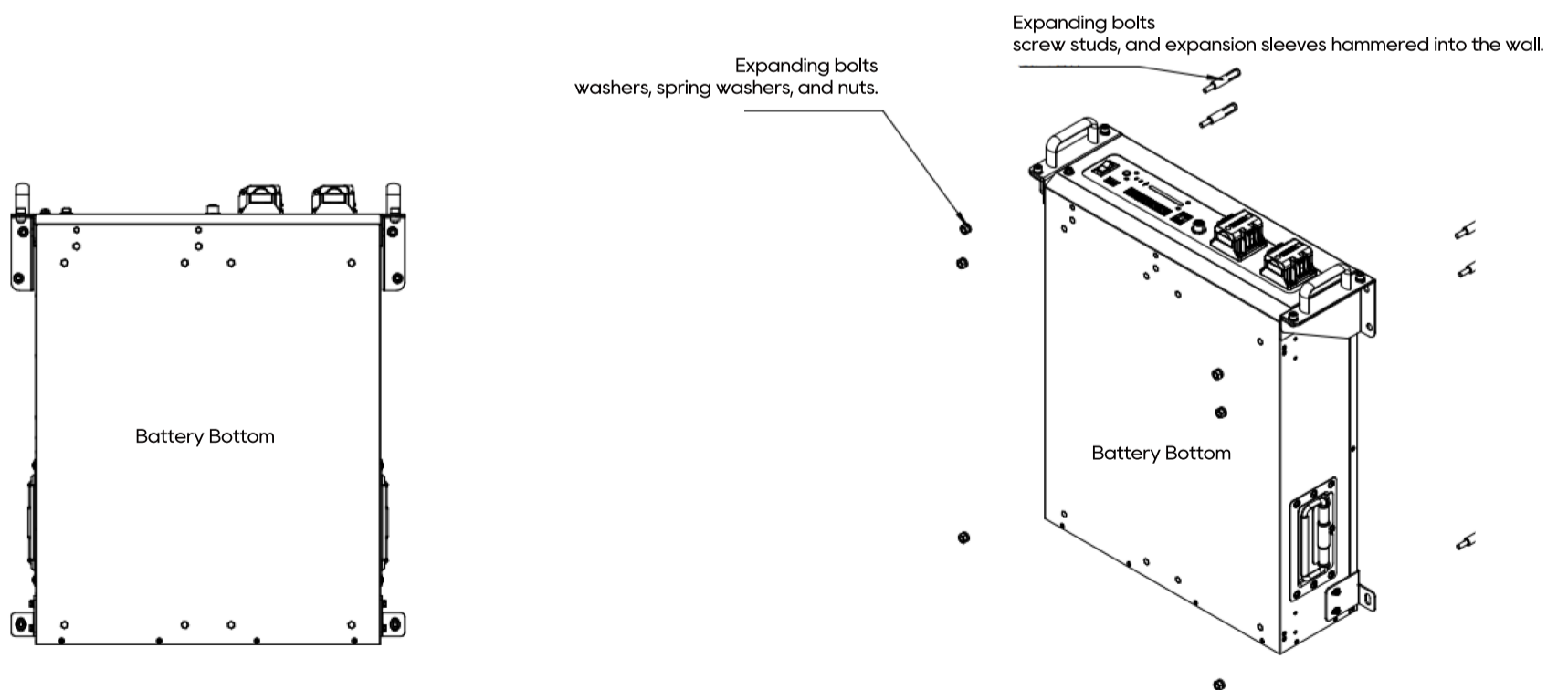

2. Install the battery to wall

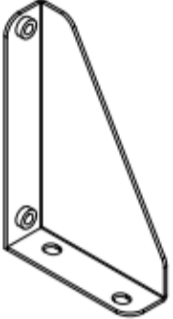
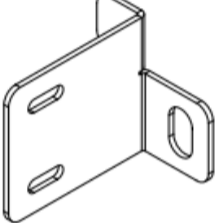
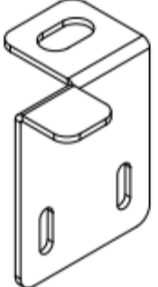

Battery Bottom View

Right Oblique View

Packing List

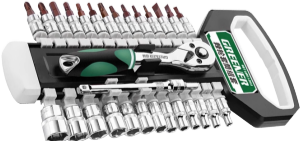
| No. | Code | Item | QTY | Specification | Picture |
|------------------|--------------|---|---|--|---|
| 1 | 150215100208 | Upper Right Bracket | 1 | 27 x 92 x 145 mm 1.06 x 3.62 x 5.71 inch (W x H x D) |  |
| 2 | 150215100216 | Upper Left Bracket | 1 | 27 x 92 x 145 mm 1.06 x 3.62 x 5.71 inch (W x H x D) |  |
| 3 | 150215100217 | Lower Right Bracket | 1 | 48 x 50 x 60 mm 1.89 x 1.97 x 2.36 inch (W x H x D) |  |
| 4 | 150215100220 | Lower Left Bracket | 1 | 48 x 50 x 60 mm 1.89 x 1.97 x 2.36 inch (W x H x D) |  |
| 5 | | M6 x 0.5" (12mm) Hexagonal cylindrical screw | 4 | ISO 10644G-2014 |  |
| 6 | | M4 x 0.4" (10mm) External hexagonal cross screw set | 4 | GB/T 70.3-2000 |  |
| 7 | | M6 x 2.4" (60mm) Expansion Screw | 6 | GB/T 22795(TC- Q)-2008 |  |
| Tools to Prepare | | |  | | |